

SPELLING



Student Book

My Name

Reading Eggspress Spelling Grade 1 Student Book

Copyright © Blake eLearning 2020

Blake Publishing
Locked Bag 2022
Glebe NSW 2037
AUSTRALIA
www.blake.com.au

Publisher: Katy Pike
Design and layout by the Modern Art Production Group

In this book



The **Reading Eggspress Spelling** program provides instruction on spelling rules, strategies, and generalizations. Each lesson focuses on a core set of 20 words, plus 10 challenge words to extend students. The crafted word lists are based on the sound, structure, and meaning of words. They support teaching of the following elements of the State Standards:

English Language Arts Standards

- Demonstrate command of the conventions of standard English capitalization, punctuation, and spelling when writing. CCSS.ELA-LITERACY.L.1.2
 - Use conventional spelling for words with common spelling patterns and for frequently occurring irregular words. CCSS.ELA-LITERACY.L.1.2.D
 - Spell untaught words phonetically, drawing on phonemic awareness and spelling conventions. CCSS.ELA-LITERACY.L.1.2.E
- Determine or clarify the meaning of unknown and multiple-meaning words and phrases based on grade 1 reading and content, choosing flexibly from an array of strategies. CCSS.ELA-LITERACY.L.1.4
 - Use sentence-level context as a clue to the meaning of a word or phrase. CCSS.ELA-LITERACY.L.1.4.A
 - Use frequently occurring affixes as a clue to the meaning of a word. CCSS.ELA-LITERACY.L.1.4.B
 - Identify frequently occurring root words (e.g., look) and their inflectional forms (e.g., looks, looked, looking). CCSS.ELA-LITERACY.L.1.4.C























































Aspects of spelling covered in this year

Aspect	Areas covered	Pages
Digraphs and trigraphs	a-e, e-e, i-e, o-e, u-e; ee, ea; ea exceptions; ar, er, ir, ur; ch, tch; oo, ou; oa, ow; ay, ai; ou, ow; or, ore; oy, oi; air, ear, are; ew, ue; wh, ph; ie, igh; au, aw	7, 8, 11, 12, 13, 14, 17, 18, 19, 20, 26, 26, 29, 30, 33, 34, 37, 38, 41, 42, 47, 48, 49, 50, 55, 56, 57, 58, 61, 62, 65, 66
Endings	double consonants; nk; plurals s es; ve; er; et, it, ot; y; le; en, on	9, 10, 15, 16, 21, 22, 27, 28, 31, 32, 39, 40, 45, 46, 53, 54, 59, 60
Prefixes	un	71, 72
Suffixes	ing; ed; er, est	43, 44, 51, 52, 63, 64



My progress chart

Name _____

Lesson	Pages	Date completed	Self-assessment – 'With this list I feel ...'
1.1 Vowels and consonants	1 - 2	/ /	  
1.2 Short vowels	3 - 4	/ /	  
1.3 Long vowels	5 - 6	/ /	  
1.4 Split digraphs – a-e, e-e, i-e, o-e, u-ei	7 - 8	/ /	  
1.5 Word endings – double consonants	9 - 10	/ /	  
1.6 Vowel digraphs – ee, ea	11 - 12	/ /	  
1.7 Vowel digraphs – ea exceptions	13 - 14	/ /	  
1.8 nk sound	15 - 16	/ /	  
1.9 Vowel digraphs – ar, er, ir, ur	17 - 18	/ /	  
1.10 Consonant digraphs and trigraphs – ch, tch	19 - 20	/ /	  
1.11 Making plurals – adding s and es	21 - 22	/ /	  
1.12 Hard k sounds	23 - 24	/ /	  
1.13 Vowel digraphs – oo and ou	25 - 26	/ /	  
1.14 Word endings – ve	27 - 28	/ /	  
1.15 Vowel digraphs – oa and ow	29 - 30	/ /	  
1.16 Word endings – er	31 - 32	/ /	  
1.17 Vowel digraphs – ay, ai	33 - 34	/ /	  
1.18 Hard and soft c	35 - 36	/ /	  

My progress chart

Name _____

Lesson	Pages	Date completed	Self-assessment – 'With this list I feel ...'
1.19 Vowel digraphs – ou and ow	37 - 38	/ /	
1.20 Word endings – et, it, ot	39 - 40	/ /	
1.21 Vowel digraphs and trigraphs – or, ore	41 - 42	/ /	
1.22 Suffixes – ing	43 - 44	/ /	
1.23 Word endings – y	45 - 46	/ /	
1.24 Vowel digraphs – oy and oi	47 - 48	/ /	
1.25 Trigraphs – air, ear, are	49 - 50	/ /	
1.26 Suffixes – ed	51 - 52	/ /	
1.27 Word endings – le	53 - 54	/ /	
1.28 Vowel digraphs – ew and ue	55 - 56	/ /	
1.29 Consonant digraphs – wh, ph	57 - 58	/ /	
1.30 Word endings – en, on	59 - 60	/ /	
1.31 Vowel digraphs and trigraphs – ie, igh	61 - 62	/ /	
1.32 Suffixes – er, est	63 - 64	/ /	
1.33 Vowel digraphs – au, aw	65 - 66	/ /	
1.34 Compound words	67 - 68	/ /	
1.35 Tricky words	69 - 70	/ /	
1.36 Prefixes – un	71 - 72	/ /	

Vowels and consonants

1.1

1 Copy each list word.

at _____ as _____ can _____ top _____
in _____ us _____ run _____ red _____
on _____ an _____ and _____ dog _____
up _____ if _____ sun _____ men _____
it _____ am _____ big _____ but _____

2 Name the picture. Write the word.

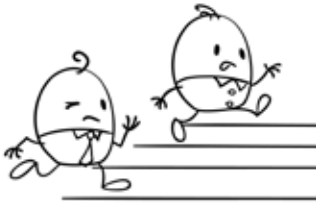

r



s



o



u

3 Opposites. Find the opposite.

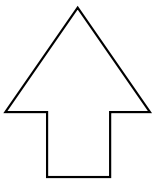

down



small



bottom



off



out



moon

Challenge words

4 Copy each challenge word.

cut _____

yet _____

zip _____

win _____

yes _____

set _____

end _____

egg _____

add _____

lots _____

5 Fill in the missing vowel.

y__t

__dd

s__t

z__p

w__n

l__ts

y__s

__gg

c__t

__nd



6 Complete the sentence.

I _____ the paper.

The hen laid an _____.

I nod and say _____.

There was _____ of food.

I can _____ two and two.

My bag has a _____.

She will _____ the race.



1 Copy each list word.

on _____ in _____ sit _____ pot _____
up _____ am _____ fog _____ bed _____
at _____ dog _____ lid _____ sat _____
it _____ map _____ bad _____ wet _____
us _____ red _____ sun _____ man _____

2 Fill in the missing letters.

I look ___p and see the s___n.

The f___g is b___d today.

I found the town ___n the m___p.

The d___g ran to ___s.

The l___d is ___n the cupboard.

We found ___t ___t the park.

I ___m going to s___t on the r___d chair.



3 Name the picture. Write the word.



m _____



d _____

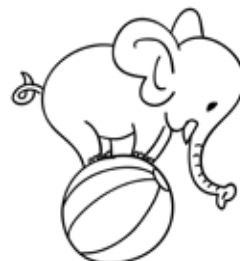

u _____

o _____

Challenge words

4 Copy each challenge word.

let	_____	rug	_____	bag	_____
cut	_____	hum	_____	act	_____
dot	_____	hid	_____		
hut	_____	ran	_____		



5 Fill in the missing letters.

I l_____ her c_____ the ribbon.
I h_____ the gift in my b_____.
The r_____ was inside the h_____.



6 Match the word to its meaning.

bag

to slice with something sharp

dot

a little mark or spot

act

something that is done

cut



you put things in me



1 Copy each list word.

no _____ by _____ dry _____ spy _____
be _____ go _____ try _____ fry _____
so _____ my _____ sky _____ most _____
me _____ he _____ cry _____ find _____
we _____ she _____ fly _____ why _____

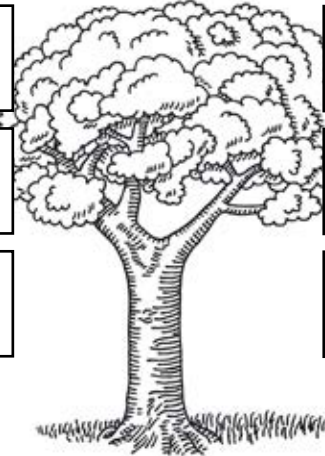
2 Sort.

o		e		i		y	
							
							
							

3 Make a list word by coloring the blocks.

mo	st	w	hy	fi	nd
	nd		nd		ld

Challenge words

4 Copy each challenge word.

kind _____

wild _____

bind _____

post _____

rind _____

child _____

wind _____

mind _____

grind _____

blind _____



5 Fit the challenge words into their word shape.

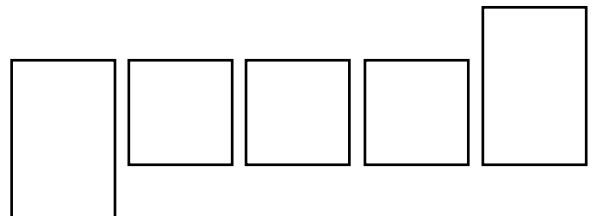
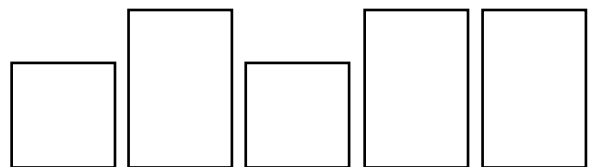
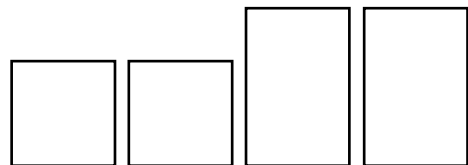
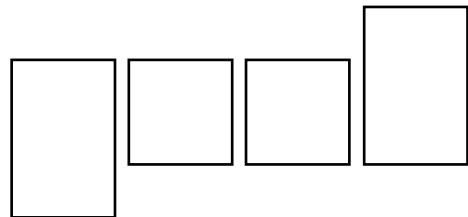
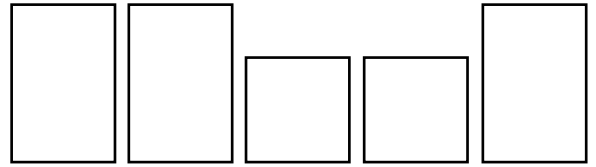

6 Complete the sentence using a challenge word.

The boy was nice and _____.

The letter came in the _____.

A mole is a _____ animal.

You can't eat the _____ of a lime.

The _____ liked her toy.

You _____ the old clock to make it work.



Split digraphs – a-e, e-e, i-e, o-e, u-e

1.4

1 Copy each list word.

bake _____ bite _____ rule _____ those _____
five _____ mole _____ close _____ cone _____
hole _____ late _____ snake _____ cube _____
cute _____ kite _____ flame _____ pole _____
came _____ rose _____ these _____ tune _____

2 Label the picture.

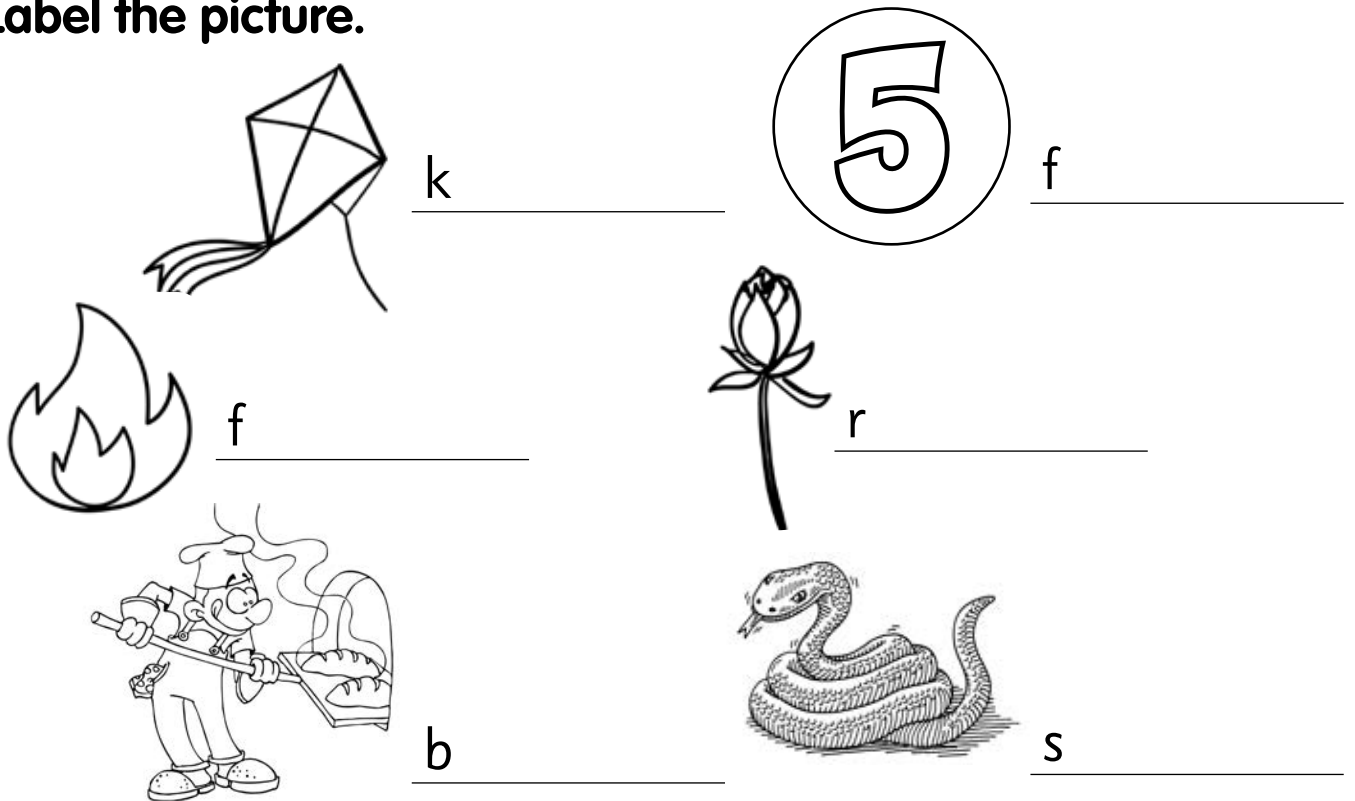

3 Fill in the missing vowel.

cl ___ se c ___ me h ___ le
l ___ te c ___ be m ___ le
c ___ te b ___ ke r ___ le

Challenge words

4 Copy each challenge word.

froze _____ spade _____ awake _____
theme _____ blaze _____ amaze _____
chose _____ slime _____
spoke _____ flake _____

5 Put each challenge word on the correct train.

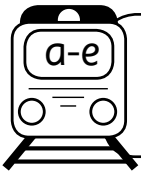

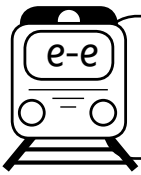

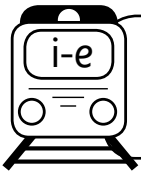

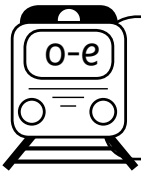

6 Choose it. Circle and rewrite the correct word to complete the sentence.

I dug with a spade spayd . _____

The lake frose froze in winter. _____

He choze chose to eat an apple. _____

She was still awake awaik late at night. _____

Word endings – double consonants

1.5

1 Copy each list word.

will _____ smell _____ boss _____
fell _____ sell _____ cross _____
hill _____ doll _____ spill _____
less _____ puff _____ grill _____
dress _____ fuss _____ pill _____
mess _____ frill _____ press _____
bell _____ still _____

2 Unscramble each word.

ff p u _____ e s ll _____
o ss b _____ ss e l _____
i ll w _____ e ll sm _____
u ss f _____ ll fr i _____
ll i st _____ e ss m _____

3 Name the picture. Write the word.

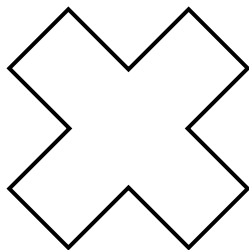

c



d



d

Challenge words

4 Copy each challenge word.

drill _____ bliss _____ floss _____
skull _____ cliff _____ stiff _____
gruff _____ bluff _____
fluff _____ skill _____

5 Choose it. Circle and rewrite the correct word to complete the sentence.

Dad says 'no' but he likes to .

Eating the ice cream filled Sam with .

My mom will her teeth each night.

There was some on my sleeve.

6 Word clues. Which challenge word matches?

high place with a steep drop _____

hard to bend _____

the bones of the head _____

a tool _____

something you do well _____



Vowel digraphs – ee, ea

1.6

1 Copy each list word.

eel _____ seen _____ each _____
bee _____ keep _____ cheat _____
feet _____ heat _____ cream _____
meat _____ teeth _____ beach _____
feed _____ green _____ clean _____
free _____ bleed _____ dream _____
read _____ cheek _____

2 Name the picture. Write the word.



b _____



m _____



f _____



t _____



r _____

3 Fill in the missing letters.

ch _____ k

bl _____ d

s _____ n

gr _____ n

_____ ch

h _____ t

f _____ d

t _____ th

d _____ a _____

k _____ p

fr _____

c _____ e _____ m

Challenge words

4 Copy each challenge word.

sheep	_____	leash	_____
peach	_____	asleep	_____
east	_____	speed	_____
agree	_____	three	_____
repeat	_____	feast	_____

5 **Interesting question.** Answer the question with a challenge word.

What means going fast? _____

What is a woolly animal? _____

Which word means *a large meal*? _____

What fruit has a thin, furry skin? _____

Which word is a number? _____

What means to do over and over? _____

6 **Hidden words.** Find the challenge word.

sdaeastshia _____

sseasleepelh _____

aspleasheahb _____

azsloagreeipq _____

rpspeachqlt _____

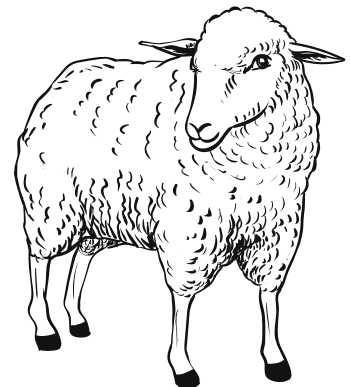

Vowel digraphs – ea exceptions

1.7

1 Copy each list word.

bread	_____	head	_____
meant	_____	ahead	_____
read	_____	heading	_____
deaf	_____	header	_____
deadly	_____	threat	_____
lead	_____	already	_____
ready	_____	thread	_____
breath	_____	health	_____
heavy	_____	healthy	_____
instead	_____	dealt	_____

2 Unscramble each word.

ea r d y	_____	l d ea	_____
h d ea a	_____	st d in ea	_____
ea th d r	_____	ea r t th	_____
f d ea	_____	r d ea	_____
ea t n m	_____	d d ea ly	_____

3 Name the picture. Write the word.



h

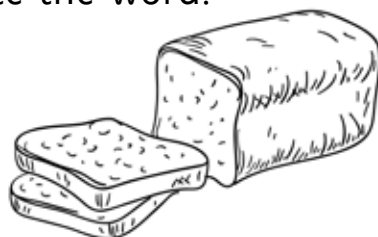

b



h

Challenge words

4 Copy each challenge word.

meadow	_____	weather	_____
dreamt	_____	measure	_____
steady	_____	treasure	_____
feather	_____	heavens	_____
leather	_____	jealous	_____

5 Choose it. Circle and rewrite the correct word to complete the sentence.

The weather wether is fine today. _____

Mom measores measures with a ruler. _____

I found the feather fether on the ground. _____

Jack dremt dreamt that he was flying. _____

6 Silly sentences. Use as many challenge words as possible to make a silly story.

1 Copy each list word.

bank _____	rink _____	stink _____
link _____	sunk _____	plank _____
pink _____	wink _____	drank _____
sink _____	junk _____	stank _____
tank _____	blank _____	trunk _____
bunk _____	blink _____	yank _____
honk _____	drink _____	

2 Unscramble each word.

nk a t _____	u nk s _____
a l b nk _____	nk p i _____
o nk h _____	r nk a _____
r a nk d _____	u nk j _____

3 Name the picture. Write the word.



b _____



s _____



d _____



w _____



l _____

Challenge words

4 Copy each challenge word.

clink	_____	chink	_____
prank	_____	oink	_____
skunk	_____	chunk	_____
think	_____	shrink	_____
thank	_____	shrunk	_____

5 **Interesting question.** Answer the question with a challenge word.

What is the sound a pig makes? _____

Which word is a type of animal? _____

What do you do with your brain? _____

What should you do when someone helps you? _____

6 **Acrostic poem.** Use the word **clink** to write an acrostic poem.

C _____

L _____

I _____

N _____

K _____

Vowel digraphs – ar, er, ir, ur

1.9

1 Copy each list word.

arm _____	cart _____	march _____
are _____	girl _____	dirt _____
car _____	bird _____	hurt _____
park _____	arch _____	farm _____
her _____	stir _____	star _____
far _____	skirt _____	paper _____
fur _____	turn _____	

2 Label. Use a list word.



c _____



b _____

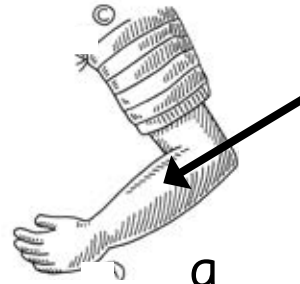

a _____

3 Write the words on the correct cars.

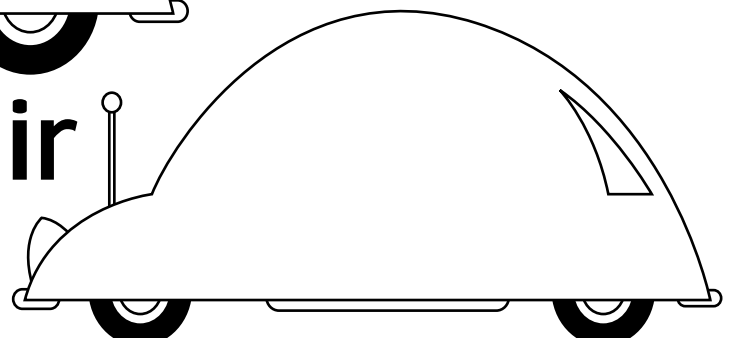
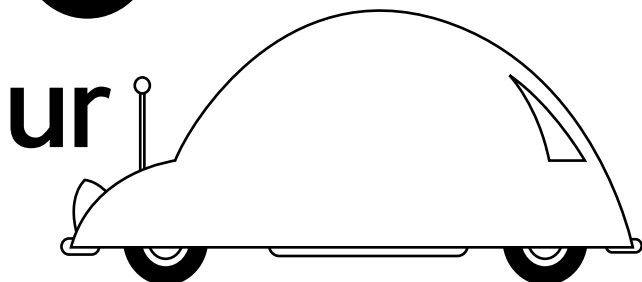
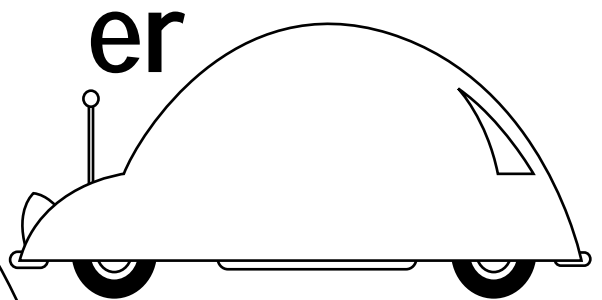
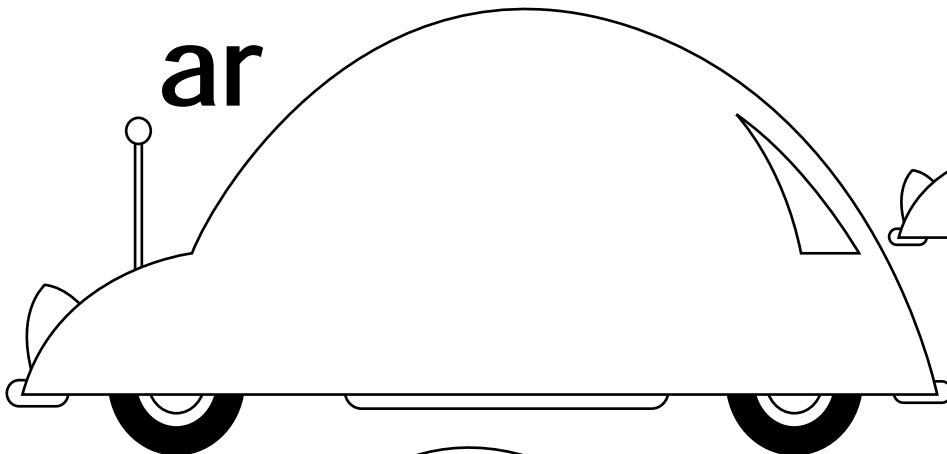

Challenge words

4 Copy each challenge word.

garden _____ smart _____

person _____ third _____

Thursday _____ start _____

thirty _____ burst _____

first _____ nurse _____

5 Word clues. Which challenge word matches?

weekday _____

to begin _____

grass and flowers _____

medical carer _____

one more than 29 _____

clever _____



6 Hidden words. Find the challenge word.

asdburstiah _____

qftpersonasu _____

asrthirdasin _____

padstartasdu _____

Consonant digraphs and trigraphs – ch, tch 1.10

1 Copy each list word.

much	_____	hatch	_____	latch	_____
such	_____	patch	_____	which	_____
itch	_____	batch	_____	watch	_____
rich	_____	pinch	_____	clutch	_____
catch	_____	hutch	_____	ditch	_____
each	_____	peach	_____	branch	_____
fetch	_____	bench	_____		

2 Label. Use a list word.



b



p

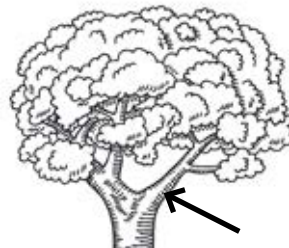

b

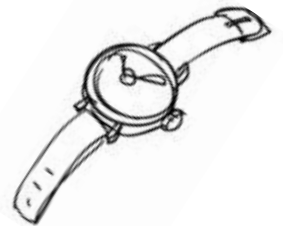

w

3 Rainbow write. Write the list words in different colors.

_____	_____	_____
_____	_____	_____
_____	_____	_____
_____	_____	_____
_____	_____	_____
_____	_____	_____
_____	_____	_____
_____	_____	_____

Challenge words

4 Copy each challenge word.

speech	_____	stretch	_____
switch	_____	march	_____
sketch	_____	torch	_____
stitch	_____	kitchen	_____
scratch	_____	butcher	_____

5 Solve it. Read the clue and complete the sentence.

What is a type of fast walking? _____

What do you do when you have an itch? _____

What room are meals cooked in? _____

Who sells meat? _____

What do you use to turn the light on? _____

What is a type of drawing? _____

6 Choose it. Circle and rewrite the correct word to complete the sentence.

I always strech stretch before I run. _____

I wrote a speech speche about tigers. _____

I used the tauch torch to see in the dark. _____















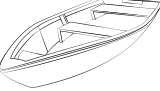

Making plurals – adding s and es

1.11

1 Copy each list word.

dogs _____ boxes _____ lunches _____
buses _____ shops _____ beaches _____
boats _____ socks _____ snakes _____
zoos _____ wishes _____ riches _____
frogs _____ peaches _____ brushes _____
bikes _____ clocks _____ plates _____
eggs _____ grapes _____

2 More than one. Write the single word and the plural word.

Challenge words

3 Copy each challenge word.

bushes	_____	dresses	_____
torches	_____	glasses	_____
benches	_____	patches	_____
gloves	_____	towers	_____
coaches	_____	churches	_____

4 Choose it. Circle and rewrite the word to complete the sentence.

I wore my glovs gloves . _____

The cat hid in the bushes bushs . _____

Mom wears glasses glases to read. _____

The towas towers were tall. _____

They used torchs torches to see in the dark. _____

The twins wore matching dresses dreses . _____

5 Solve it. Read the clue and complete the sentence.

You put us on torn clothes. We are _____ .

You sit on us to wait for the bus. We are _____ .

You wear us to help you see. We are _____ .

We are green and leafy. We are _____ .

1 Copy each list word.

act	_____	skin	_____	kept	_____
kiss	_____	curl	_____	skill	_____
cone	_____	cash	_____	snake	_____
cool	_____	clash	_____	scrape	_____
keep	_____	come	_____	husky	_____
kind	_____	keen	_____	coal	_____
card	_____	donkey	_____		

2 Sort the words.

Words with the letter c.



Words with the letter k.

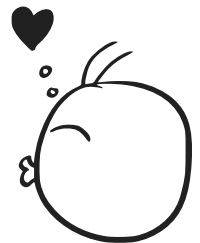

3 Unscramble it. Unscramble the letters to make a list word.

pecrsa	_____	hcsa	_____
eekp	_____	liksl	_____

Challenge words

4 Copy each challenge word.

cheeky	_____	awoke	_____
sneaky	_____	crayon	_____
kitten	_____	cabin	_____
biscuit	_____	castle	_____
kettle	_____	monkey	_____

5 Hidden words. Find the challenge word.

asdcrayonasdy _____

asjfmonkeyasdy _____

wahdawokeasd _____

sdfbcastlezsd _____

cwplcabinasdu _____

vsdfgkettleasd _____



6 Match the clue to a challenge word.

1.			s			
2.				i		
3.		i				
4.		h				
5.					k	

1. something you eat
2. a room on a ship
3. a young cat
4. rude or annoying
5. acting in a secret way

Vowel digraphs – oo and ou

1.13

1 Copy each list word.

too _____ roof _____ tooth _____
zoo _____ food _____ soup _____
you _____ cook _____ stool _____
book _____ hood _____ mood _____
moon _____ boot _____ shook _____
good _____ bloom _____ droop _____
look _____ broom _____

2 Fill in the missing words.

I am _____ at math.

The _____ shines at night.

I have read that _____.

I saw an elephant at the _____.

I love a hot bowl of _____.

He was in a bad _____.

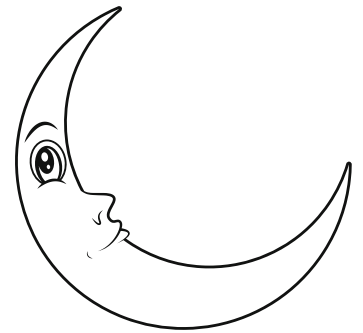

3 Rhyming words. Choose a list word that rhymes with the word.

zoo _____
book _____
bloom _____
food _____
good _____



Challenge words

4 Copy each challenge word.

swoop	_____	raccoon	_____
group	_____	hooray	_____
spoon	_____	balloon	_____
goose	_____	bamboo	_____
choose	_____	baboon	_____

5 Solve it. Read the clue and complete the sentence.

You can blow me up. I am a _____.

You can use me to eat with. I am a _____.

I lay eggs and swim in the water. I am a _____.

I am a large monkey. I am a _____.

I am something a bird does. I am _____.

Pandas eat me. I am _____.

6 Hidden words. Find the challenge word.

aujerraccoonhayj _____

grplgroupasi _____

asdechoosehalh _____

asdhoorayasui _____

blkballoonklnbl _____

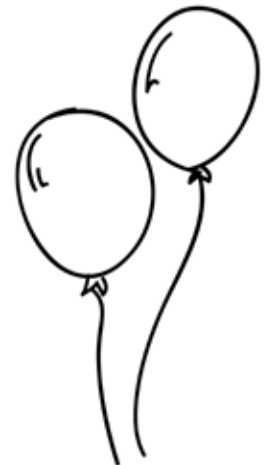

Word endings – ve

1.14

1 Copy each list word.

eve _____ glove _____ improve _____
have _____ nerve _____ remove _____
live _____ dove _____ valve _____
love _____ above _____ curve _____
move _____ carve _____ active _____
leave _____ twelve _____ sleeve _____
serve _____ prove _____

2 Write the list words in alphabetical order.

3 Name the picture. Use a list word.



g



l

12

t



s



d



a

Challenge words

4 Copy each challenge word.

olive _____

swerve _____

solve _____

massive _____

shove _____

believe _____

halve _____

arrive _____

starve _____

forgive _____

5 Choose it. Circle and rewrite the correct word to complete the sentence.

The new building is massive masiv. _____

I ate the oliv olive. _____

I will forgiv forgive my brother. _____

He will solv solve the crime. _____

We had to swerv swerve to miss the bird. _____

She will halve halv the apple and share it. _____

6 Words within words. Can you rearrange the letters in **massive** to make 6 new words?

Vowel digraphs – oa and ow

1.15

1 Copy each list word.

oak _____ soap _____ show _____
bow _____ coat _____ owe _____
row _____ toad _____ slow _____
oats _____ crow _____ own _____
low _____ soak _____ cloak _____
boat _____ glow _____ bowl _____
road _____ moan _____

2 Sort the words.

oa

ow

_____	_____	_____	_____
_____	_____	_____	_____
_____	_____	_____	_____
_____	_____	_____	_____
_____	_____	_____	_____

3 Correct it. Rewrite the misspelled word with the correct spelling.

We went sailing on the bote. _____

Mom tied a bo in my hair. _____

The bole was full of berries. _____

We had to roe the boat to shore. _____

The lights made the tree gloe. _____

Challenge words

4 Copy each challenge word.

blown _____	boast _____
groan _____	croak _____
grown _____	roast _____
coast _____	elbow _____
coach _____	below _____

5 Complete the sentence.

We had _____ potatoes for dinner.

My _____ is part of my arm.

I have _____ taller.

I watched the people walking _____.

The leaves had _____ all over the yard.

The frog makes a noise that sounds like _____.



6 Acrostic poem. Use the word **coast** to write an acrostic poem.

C _____
O _____
A _____
S _____
T _____

1 Copy each list word.

ever _____ finger _____ corner _____
under _____ sister _____ clever _____
never _____ mother _____ flower _____
enter _____ other _____ father _____
water _____ teacher _____ gather _____
silver _____ wonder _____ counter _____
winter _____ player _____

2 Addition words. Add the two parts to make the word.

sist	+	er	=	_____
und	+	er	=	_____
wint	+	er	=	_____
wond	+	er	=	_____

3 Label it. Use a list word.



f _____

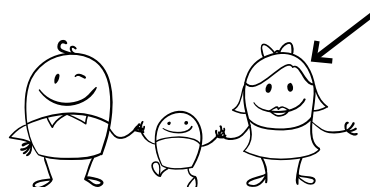

m _____



w _____



f _____

Challenge words

4 Copy each challenge word.

cover	_____	swimmer	_____
brother	_____	butter	_____
monster	_____	ladder	_____
letter	_____	winner	_____
matter	_____	together	_____

5 Choose it. Circle and rewrite the correct word to complete the sentence.

I my mouth if I sneeze.

Grandma sent me a .

He climbed up the .

We go to school .

She likes on her bread.

She is a great .

6 Hidden words. Find the challenge word.

gflmatterash _____

qplcmonsterkhyw _____

stlebrothermalo _____

whkwinnerndw _____

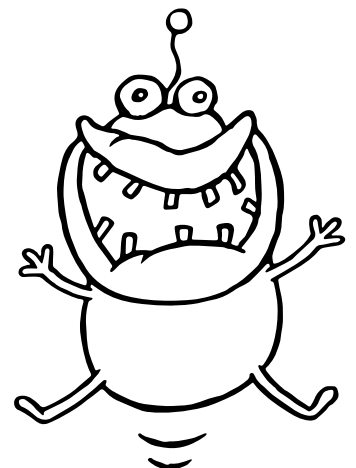

1 Copy each list word.

say _____	stay _____	claim _____
day _____	sail _____	brain _____
aim _____	pain _____	sway _____
may _____	tail _____	grain _____
play _____	plain _____	paint _____
main _____	snail _____	stain _____
rain _____	chain _____	

2 Sort the words.

ay	ai		
_____	_____	_____	_____
_____	_____	_____	_____
_____	_____	_____	_____
_____	_____	_____	_____
_____	_____	_____	_____
_____	_____	_____	_____
_____	_____	_____	_____

3 Rhyming words. Choose a list word that rhymes.

plain _____

sway _____

tail _____

Challenge words

4 Copy each challenge word.

again	_____	stray	_____
away	_____	faint	_____
braid	_____	spray	_____
waist	_____	sprain	_____
today	_____	always	_____

5 Interesting question. Answer these questions using the challenge words.

What can you do with your hair? _____

What is a part of your body? _____

What is another word for repeat? _____

What day is it right now? _____

What might you do after a dizzy spell? _____

What might you do if you fall on your wrist? _____

6 Silly sentences. Use as many challenge words as possible to make a silly story.

1 Copy each list word.

act	_____	mice	_____	fence	_____
ice	_____	curl	_____	slice	_____
code	_____	cent	_____	space	_____
clam	_____	crash	_____	scale	_____
face	_____	place	_____	price	_____
cube	_____	dance	_____	once	_____
corn	_____	twice	_____		

2 Fill in the missing letters.

Ballet is a style of d____c_____.

The rocket flew into s____c_____.

A c____b____ has six faces.

Grandma cut me a s____c_____ of chocolate cake.

She had m____c_____ as her pets.

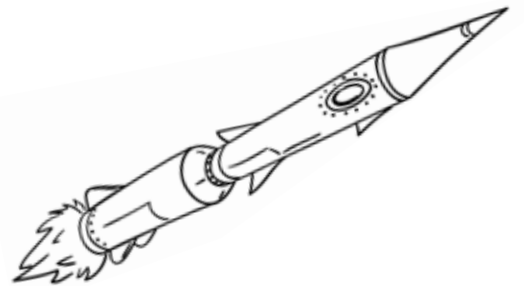

3 Unscramble it. Unscramble the letters to make the list word.

shrac	_____	cie	_____
eciwt	_____	mlac	_____
cta	_____	paces	_____
nfcee	_____	lruc	_____
nceo	_____	cfea	_____
nroc	_____	deoc	_____

Challenge words

4 Copy each challenge word.

fleece _____ prince _____

corner _____ cattle _____

juice _____ crunch _____

pencil _____ chance _____

coming _____ circus _____

5 Word clues. Which challenge word matches?

royalty _____

clowns, animals, and acrobats _____

something you write with _____

an eating sound _____

something you can drink _____

animals that produce milk _____



6 Choose it. Circle and rewrite the word to complete the sentence.

The cattel cattle ate a lot of grass. _____

We got the fleece fleese from a sheep. _____

There is a chanse chance it will rain. _____

I will be coming comeing to your party! _____

Vowel digraphs – ou and ow

1.19

1 Copy each list word.

bow	_____	loud	_____	proud	_____
cow	_____	sow	_____	gown	_____
our	_____	noun	_____	brown	_____
now	_____	cloud	_____	sound	_____
owl	_____	count	_____	clown	_____
how	_____	fowl	_____	mouth	_____
row	_____	town	_____		

2 Label it. Use a list word.

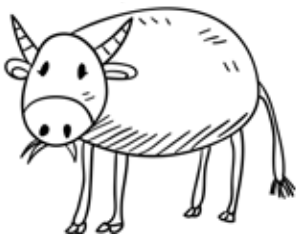

c _____

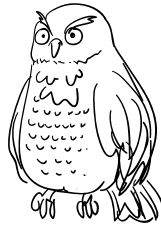

o _____



c _____



c _____

3 Sort the words.

OU

OW

Challenge words

4 Copy each challenge word.

mountain	_____	couch	_____
growl	_____	frown	_____
drown	_____	flour	_____
crowd	_____	bound	_____
found	_____	about	_____

5 Choose it. Circle and rewrite the correct word to complete the sentence.

We made the cake with flower flour . _____

I found fonde her behind the chair. _____

The croud crowd cheered loudly. _____

I frowne frown when I am sad. _____

My dogs grole growl at strangers. _____

I read about aboot China. _____

The moundain mountain is high. _____

6 Hidden words. Find the challenge word.

asdmountainln _____ adfaboutyeh _____

sdafloursyha _____ adercouchloq _____

asddrownasia _____ asdboundasiu _____

Word endings – et, it, ot

1.20

1 Copy each list word.

pocket _____ visit _____ rabbit _____
ticket _____ pilot _____ carrot _____
planet _____ helmet _____ puppet _____
jacket _____ goblet _____ bonnet _____
bucket _____ market _____ blanket _____
packet _____ carpet _____ basket _____
rocket _____ secret _____

2 Circle the correct ending and rewrite the word.

pack **et** _____ rabb **et** _____
ot _____ **it** _____
pil **et** _____ secr **et** _____
ot _____ **it** _____
carr **ot** _____ vis **ot** _____
et _____ **it** _____

3 Label it. Use a list word.



h _____

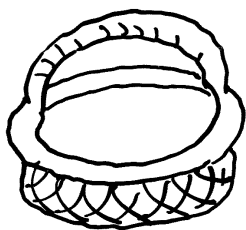

b _____

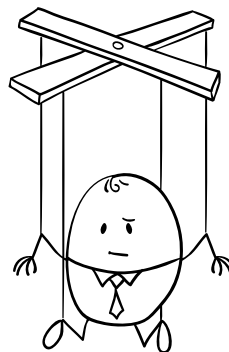

p _____



r _____

Challenge words

4 Copy each challenge word.

tablet	_____	comet	_____
target	_____	cricket	_____
wallet	_____	velvet	_____
trumpet	_____	violet	_____
ferret	_____	toilet	_____

5 Complete the sentence.

He plays the _____ in the band.

The _____ flew through space.

The _____ had brown fur.

I keep money in my _____.

Our curtains are made of thick _____.

Dad reads a book on his computer _____.



6 Interesting question. Answer the question using a challenge word.

What can you flush? _____

What is a type of flower? _____

What do you shoot an arrow at? _____

What is an insect that makes a loud noise? _____

Vowel digraphs and trigraphs – or, ore

1.21

1 Copy each list word.

or	_____	torn	_____	torch	_____
sore	_____	fort	_____	horse	_____
more	_____	port	_____	chore	_____
for	_____	snore	_____	acorn	_____
corn	_____	shore	_____	store	_____
fork	_____	ashore	_____	score	_____
horn	_____	before	_____		

2 Fill in the words. Name the picture to complete the sentence.

We ate _____ for dinner.



Jack rode a _____.



We took a trip to the sea _____.

The flame on a _____ is hot.

3 Unscramble it. Unscramble the letters to make a list word.

ropt	_____	orme	_____
ecohr	_____	nsoer	_____
osrec	_____	hoalers	_____
ro	_____	rfo	_____

Challenge words

4 Copy each challenge word.

adore _____

border _____

sport _____

force _____

storm _____

airport _____

afford _____

morning _____

corner _____

enormous _____

5 Solve it. Read the clue and complete the sentence.

Planes take off and land here. I am an _____.

You can play me. I am _____.

I am very large. I am _____.

I have thunder and lightning. I am a _____.

I happen before 12 pm. I am _____.

A triangle has three of me. I am a _____.

6 Hidden words. Find the challenge word.

pveadoregha _____

lheforceauk _____

cmtaffordqel _____

splborderanh _____



1 Copy each list word.

ending _____ feeling _____ fetching _____
eating _____ wishing _____ reaching _____
sailing _____ locking _____ drinking _____
looking _____ going _____ speaking _____
saying _____ thinking _____ thanking _____
playing _____ speeding _____ floating _____
meeting _____ opening _____

2 Label it. Use a list word.



d _____



p _____



f _____



e _____

3 Rainbow write. Write each list word in a different color.

Challenge words

4 Copy each challenge word.

blowing	_____	wondering	_____
brushing	_____	gathering	_____
tracking	_____	watering	_____
watching	_____	smelling	_____
covering	_____	scratching	_____

5 Hidden words. Find the challenge word.

fhitrackingysak _____
xetgatheringpvc _____
plrcoveringyij _____
ovtscratchingetcn _____
wbctwonderingeli _____



6 Choose it. Circle and rewrite the correct word to complete the sentence.

She was smeling smelling the roses. _____

The wind was bloeing blowing strongly. _____

Mom was watering waterng the plants. _____

My sister was waching watching TV. _____

He was brushing brusing the dog. _____

The storm clouds were gathering gathring in the sky. _____

1 Copy each list word.

cry _____ tidy _____ sorry _____
sky _____ lazy _____ funny _____
fly _____ ugly _____ story _____
very _____ happy _____ party _____
copy _____ busy _____ city _____
body _____ easy _____ pretty _____
baby _____ puppy _____

2 Name the picture.



p _____



c _____

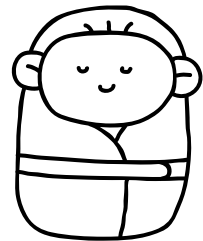

b _____



c _____



h _____



s _____

3 Unscramble it. Unscramble the letters to make the list word.

nfuyn _____ zlay _____

yrev _____ tpyert _____

iydt _____ seay _____

Challenge words

4 Copy each challenge word.

many	_____	empty	_____
fairy	_____	angry	_____
fancy	_____	dirty	_____
ready	_____	clumsy	_____
heavy	_____	family	_____

5 Solve it. Read the clue and complete the sentence with a list word.

It is not light. It is _____.

I am not full. I am _____.

I am covered in mud. I am _____.

The people related to you are your _____.

If I have a lot of something, I have _____.

I'm a magical creature with wings. I am a _____.

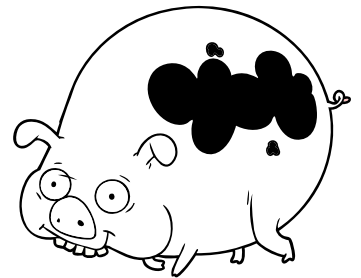

6 Silly sentences. Use as many challenge words as possible to make a silly story.

Vowel digraphs – oy and oi

1.24

1 Copy each list word.

oil	_____	soil	_____	ahoy	_____
boy	_____	join	_____	oink	_____
toy	_____	moist	_____	foil	_____
joy	_____	spoil	_____	cowboy	_____
noise	_____	enjoy	_____	royal	_____
boil	_____	oily	_____	joyful	_____
coin	_____	point	_____		

2 Correct it. Correct the misspelled word.

I really enjoi going to the beach. _____

The boi liked to run very fast. _____

I found a coyn in my pocket. _____

The coweboy wore a hat and boots. _____

3 Sort the words.

oy

oi

Challenge words

4 Copy each challenge word.

annoy _____

foyer _____

coy _____

avoid _____

coil _____

joint _____

destroy _____

toil _____

loyal _____

voice _____

5 Acrostic poem. Use the word **toil** to write an acrostic poem.

T
_____O
_____I
_____L

6 Choose it. Circle and rewrite the correct word to complete the sentence.

The snake lay in a coyl coil in the sun. _____

We waited in the hotel foier foyer. _____

She had a sweet singing voice voyce. _____

The dog was very loyal loial. _____

My elbow joynt joint was sore. _____

I'll leave early to avoid avoyd the rain. _____

1 Copy each list word.

air	_____	pear	_____	chair	_____
ear	_____	pair	_____	share	_____
fair	_____	dear	_____	stair	_____
dare	_____	care	_____	spare	_____
fear	_____	near	_____	smear	_____
hair	_____	year	_____	spear	_____
hear	_____	wear	_____		

2 Complete the word. Fill in the letters to make the list word.

c _ _ _
n _ _ _

y _ _ _
sh _ _ _

a _ _
sm _ _ _

3 Label it.



c _____

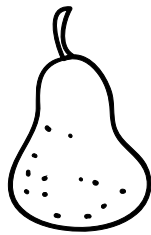

p _____



h _____

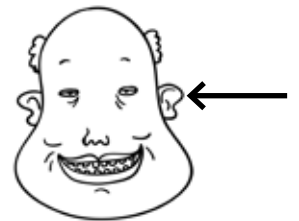

e _____

4 Fill in the words.

She brushed her h_____.

I h_____ with my ears.

I d_____ you to tell the truth.

My puppy is d_____ to me.



Challenge words

5 Copy each challenge word.

beard	_____	wear	_____
scared	_____	nearby	_____
fairy	_____	square	_____
upstairs	_____	nightmare	_____
repair	_____	parent	_____

6 **Interesting question.** Answer the questions using a challenge word.

What is something you feel? _____

What is a magical creature with wings? _____

What is a name for a mother or father? _____

What is the hair on a face? _____

What is a four-sided shape? _____

What do you call a bad dream? _____

7 **Acrostic poem.** Write an acrostic poem using the word **beard**.

B _____

E _____

A _____

R _____

D _____

1 Copy each list word.

looked _____ played _____ cheated _____
wished _____ rushed _____ smiled _____
pulled _____ hired _____ roasted _____
rained _____ parked _____ blamed _____
cared _____ turned _____ washed _____
picked _____ shared _____ showed _____
cooked _____ choked _____

2 Write the word in the brackets correctly.

I (pick) _____ it up yesterday.

Last time he (cheat) _____.

Dad (cook) _____ dinner last night.

She (choke) _____ trying to swallow the meat.

We (hire) _____ a jumping castle for my party.

Yesterday I (share) _____ my lunch with my friend.

3 Addition words. Add the two parts to make the word.

wish	+	ed	=	_____
turn	+	ed	=	_____
look	+	ed	=	_____



Challenge words

4 Copy each challenge word.

called	_____	spilled	_____
freed	_____	crouched	_____
dressed	_____	grouped	_____
fetches	_____	stitched	_____
growled	_____	wondered	_____

5 Hidden words. Find the challenge word.

dfdressedasu	_____	tawonderedaj	_____
sscrouchedau	_____	plwfreedaaid	_____
avstitchedaoi	_____	pcgroupedhg	_____

6 Choose it. Circle and rewrite the correct word to complete the sentence.

The dog grouled growled loudly at me. _____

She spilled spilet her drink everywhere. _____

I called kalled my grandma yesterday. _____

I croached crouched down low. _____

I wundered wondered what time we would arrive. _____

I grouped grooped together the different types of shells. _____

1 Copy each list word.

able _____ little _____ jungle _____
uncle _____ bottle _____ cradle _____
candle _____ cuddle _____ juggle _____
apple _____ needle _____ purple _____
table _____ tickle _____ eagle _____
ankle _____ middle _____ bubble _____
kettle _____ chuckle _____

2 Label it.

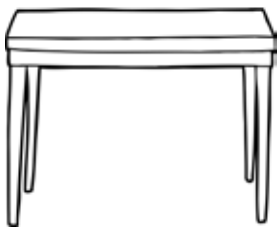

t



b



k



a

3 Rainbow write these list words.

able _____
purple _____
uncle _____
chuckle _____
middle _____
little _____



Challenge words

4 Copy each challenge word.

castle	_____	freckle	_____
tremble	_____	struggle	_____
crumble	_____	circle	_____
startle	_____	bicycle	_____
sprinkle	_____	miracle	_____

5 Solve it. Read the clue and complete the sentence.

I am a large house where a king lives. I am a _____.

I have two wheels and a seat. I am a _____.

I am a shape with no corners. I am a _____.

I am a dot on the skin. I am a _____.

I am like a shiver. I am a _____.

I am an amazing event. I am a _____.

6 Silly sentence. Use as many challenge words as possible to make a silly story.

Vowel digraphs – ew and ue

1 Copy each list word.

dew	_____	chew	_____	due	_____
blew	_____	blue	_____	threw	_____
true	_____	drew	_____	grew	_____
new	_____	flew	_____	screw	_____
clue	_____	crew	_____	value	_____
few	_____	glue	_____	knew	_____
stew	_____	pew	_____		

2 Fill in the correct digraph.

bl	_____	n	_____
thr	_____	kn	_____
gl	_____	bl	_____



3 Write the list words in alphabetical order.

_____	_____	_____
_____	_____	_____
_____	_____	_____
_____	_____	_____
_____	_____	_____
_____	_____	_____
_____	_____	_____
_____	_____	_____

Challenge words

4 Copy each challenge word.

venue	_____	barbecue	_____
nephew	_____	Tuesday	_____
avenue	_____	rescue	_____
pursue	_____	jewel	_____
cashew	_____	argue	_____

5 Interesting question. Answer the question using a challenge word.

What can you cook on? _____

What is another word for disagree? _____

What is a type of street? _____

6 Choose it. Circle and rewrite the correct word to complete the sentence.

The jewll jewel in her ring was green. _____

I am my aunt's nephew nephue. _____

I love to eat cashue cashew nuts. _____

Tuesday Tuseday is library day. _____

They plan to rescue rescew the hiker. _____

1 Copy each list word.

- why _____
- what _____
- when _____
- where _____
- wheel _____
- white _____
- which _____
- while _____
- whale _____
- whip _____
- whack _____
- wheat _____
- whirl _____
- whisk _____
- whine _____
- phone _____
- photo _____
- nowhere _____
- somewhere _____
- anywhere _____

2 Label it.



p _____



w _____

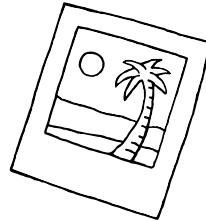

p _____

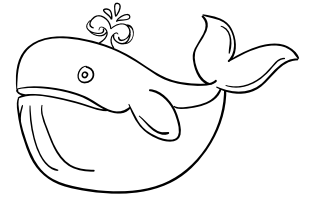

w _____

3 Chunks. Put the list words back together.

ea-wh-t _____

i-ch-wh _____

ere-wh _____

ck-a-wh _____

i-wh-te _____

wh-an-ere-y _____

wh-no-ere _____

a-t-wh _____

y-wh _____

wh-so-er-me-e _____

e-n-wh _____

l-ir-wh _____

Challenge words

4 Copy each challenge word.

whisper	_____	nephew	_____
dolphin	_____	orphan	_____
phonics	_____	phew	_____
alphabet	_____	wharf	_____
elephant	_____	whether	_____

5 Solve it. Read the clue and complete the sentence.

I have a long trunk. I am an _____.

I have 26 letters. I am the _____.

I live in water and have a blowhole. I am a _____.

Boats and ships dock here. I am a _____.

I am someone who has no parents. I am an _____.

I am difficult to hear. I am a _____.

6 Hidden words. Find the challenge word.

weaphewauea _____
lemwhetherpqz _____
phonicsuebsky _____
tlenephewiah _____

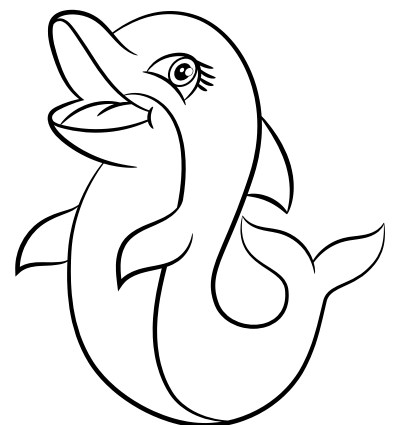

1 Copy each list word.

even _____ chicken _____ dragon _____
seven _____ children _____ wooden _____
oven _____ apron _____ cotton _____
garden _____ lesson _____ ribbon _____
lemon _____ sudden _____ button _____
wagon _____ golden _____ happen _____
open _____ kitten _____

2 Addition words. Add the two parts to make the word.

lem	+	on	=	
op	+	en	=	
less	+	on	=	
chick	+	en	=	

3 Label it. Use a list word.

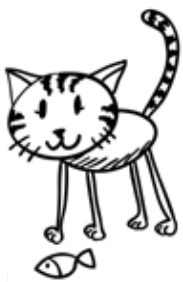

k _____

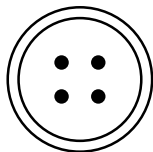

b _____

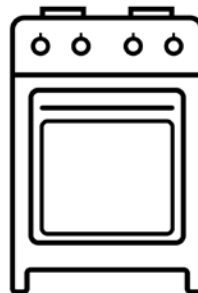

o _____



d _____

Challenge words

4 Copy each challenge word.

person	_____	eleven	_____
season	_____	onion	_____
pardon	_____	poison	_____
bacon	_____	carton	_____
kitchen	_____	listen	_____

5 Interesting question. Answer each question using a challenge word.

What do you do with your ears? _____

Where do you cook? _____

What is the sum of ten and one? _____

What is summer? _____

What is a meat you often eat with eggs? _____

What is something that can harm or kill? _____

6 Silly sentence. Use as many challenge words as possible to make a silly story.

Vowel digraphs and trigraphs – ie, igh 1.31

1 Copy each list word.

die	_____	dries	_____	light	_____
lie	_____	spied	_____	right	_____
tie	_____	fried	_____	might	_____
pie	_____	thigh	_____	sight	_____
high	_____	chief	_____	fight	_____
tries	_____	thief	_____	tight	_____
cried	_____	night	_____		

2 Fill in the words. Complete the sentence using a list word.

The sun is h _ _ _ in the sky.

The bird s _ _ _ _ a worm on the ground.

The child c _ _ _ _ when he got hurt.

The c _ _ _ _ welcomed the visitors to his village.

I can t _ _ my shoelaces.

She cut me a piece of the p _ _ .

She d _ _ _ _ her face with a towel.

We had f _ _ _ _ chicken for lunch.



3 Unscramble these words.

iefth	_____	ihgts	_____
tghti	_____	ghtri	_____
iet	_____	ihgth	_____

Challenge words

4 Copy each challenge word.

tonight	_____	grief	_____
bright	_____	believe	_____
flight	_____	fright	_____
slight	_____	delight	_____
belief	_____	replies	_____

5 Choose it. Circle and rewrite the correct word to complete the sentence.

The large dog gave me a fright frite. _____

The full moon was very brite bright. _____

She cried with grief grief. _____

Our flight flite to Kansas leaves soon. _____

6 Acrostic poem. Use the word **fright** to write an acrostic poem.

F

R

I

G

H

T

1 Copy each list word.

older _____	neatest _____	fresher _____
oldest _____	faster _____	freshest _____
longer _____	fastest _____	taller _____
longest _____	louder _____	tallest _____
later _____	loudest _____	shorter _____
latest _____	thicker _____	shortest _____
neater _____	thickest _____	

2 Sort the words.

er

est

3 Chunks. Rearrange the letters to make the list word.

est-st-fa _____	at-est-ne _____
ll-er-ta _____	ng-er-lo _____
rt-est-sho _____	sh-fr-er-e _____

Challenge words

4 Copy each challenge word.

quieter _____ brightest _____

quietest _____ younger _____

calmer _____ youngest _____

calmest _____ higher _____

brighter _____ highest _____

5 Complete the sentence.

My spelling score was _____ than Toby's.

His motorcycle is _____ than my dad's.

The sun shone the _____ in the middle of the day.

6 Choose it. Circle and rewrite the correct word to complete the sentence.

The sea is today than yesterday.

I climbed the tree.

I am the of all my cousins.

My bedroom is the place
in our home.

Vowel digraphs – au, aw

1.33

1 Copy each list word.

paw _____ lawn _____ dawn _____
 raw _____ hawk _____ haul _____
 saw _____ yawn _____ crawl _____
 jaw _____ straw _____ haunt _____
 law _____ thaw _____ fault _____
 claw _____ gawk _____ seesaw _____
 draw _____ shawl _____

2 Name the picture.



s _____



p _____



d _____



h _____

3 Match the clue to a list word.

1.			r		
2.	l				
3.			w		
4.				k	
5.	s				
6.		h			
7.					l

1. dried grass
2. a rule
3. not cooked
4. stare
5. used to cut
6. melt
7. how a baby moves



Challenge words

4 Copy each challenge word.

awful	_____	drawer	_____
prawn	_____	laundry	_____
saucer	_____	fawn	_____
jigsaw	_____	August	_____
scrawl	_____	author	_____

5 **Solve it.** Read the clue and complete the sentence.

I am another name for a puzzle. I am a _____.

I write books. I am an _____.

I am messy writing. I am a _____.

You place me underneath a cup. I am a _____.

I slide in and out and hold items. I am a _____.

I am a young deer. I am a _____.

6 **Hidden words.** Find the challenge word.

khYrAugustPfhj _____

ybvprawnhqt _____

lhqilaundryemfd _____

agvawfuloutn _____

slxyfawnkpst _____

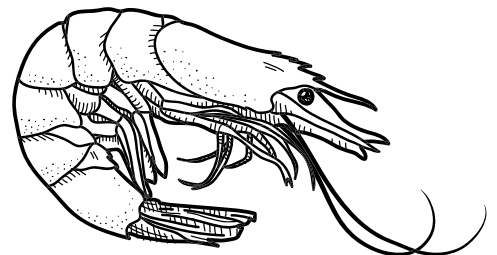

1 Copy each list word.

football _____

playground _____

farmyard _____

bedroom _____

handbag _____

strawberry _____

cupcake _____

bedtime _____

sunset _____

bullfrog _____

clockwork _____

baseball _____

popcorn _____

seaside _____

bathroom _____

sunshine _____

daydream _____

goldfish _____

weekend _____

postcard _____

2 Write the compound word.

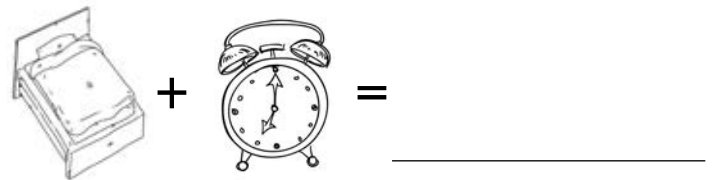

3 Meaning. Which list word means?

a small fish _____

a small red fruit _____

a game played with a bat and ball _____

to dream about something while awake _____

somewhere that children play _____

an animal that croaks _____

Challenge words

4 Copy each challenge word.

footpath _____

haircut _____

jellyfish _____

birthday _____

sunflower _____

someone _____

grandson _____

butterfly _____

grandmother _____

something _____

5 Silly sentence. Use as many challenge words as possible to make a silly story.

6 Interesting question. Answer each question using a challenge word.

Who is your mother's mother? _____

What is pretty and flies? _____

Where do you walk? _____

What do you have once a year? _____

How do you get shorter hair? _____

1 Copy each list word.

do	_____	was	_____	says	_____
to	_____	go	_____	here	_____
the	_____	you	_____	there	_____
of	_____	your	_____	she	_____
no	_____	where	_____	ask	_____
by	_____	they	_____	were	_____
are	_____	said	_____		

2 Sort the words.

2 letters

_____	_____	_____
_____	_____	_____
_____	_____	_____

3 letters

_____	_____	_____
_____	_____	_____
_____	_____	_____

4 letters

_____	_____	_____
_____	_____	_____
_____	_____	_____

more than 4 letters

_____	_____	_____
_____	_____	_____
_____	_____	_____

Challenge words

3 Copy each challenge word.

come

once

some

put

friend

push

school

pull

one

full

4 Choose it. Circle and rewrite the correct word to complete the sentence.

I've been to Disneyland wonce once . _____

Dad gave me a push poosh on the swing. _____

I was allowed one won scoop of ice cream. _____

My frend friend and I are going to the park today. _____

5 Hidden words. Find the challenge word.

shlschoolkeb _____

stzfulluhb _____

lnbcomeplst _____

lhfputerx _____

lvesomehuq _____



1 Copy each list word.

undo _____ unfit _____ unwind _____
undid _____ unplug _____ unblock _____
untie _____ unpack _____ uneven _____
unzip _____ unable _____ untrue _____
unlock _____ undone _____ unroll _____
unlike _____ unwise _____ unsafe _____
unkind _____ untidy _____

2 Chunks. Rearrange the letters to make the list word.

nd–un–ki _____ li–ke–un _____
le–ab–un _____ nd–un–wi _____
ck–un–lo _____ pa–ck–un _____
ug–pl–un _____ ev–un–en _____
ti–un–dy _____ sa–un–fe _____

3 Correct it. Correct the misspelled word.

The story she told you was unntru. _____

I had to unplugg the computer. _____

I helped untye her shoelaces. _____

It is unnsaf to swim in that river. _____

Challenge words

4 Copy each challenge word.

unwrap	_____	unhappy	_____
unfair	_____	unusual	_____
uncover	_____	unclear	_____
unlucky	_____	unhealthy	_____
unafraid	_____	unfriendly	_____

5 Silly sentence. Use as many challenge words as possible to make a silly story.



6 Solve it. Read the clue and complete the sentence.

You do this to a present. You _____ it.

When someone is sad they feel _____.

Too much junk food is _____.

Something surprising or interesting is _____.

When you feel brave you feel _____.

When something is confusing it is _____.